

Article number: 6100110071071

Description: 12B1

Extended pin one side only, connecting link

Measures

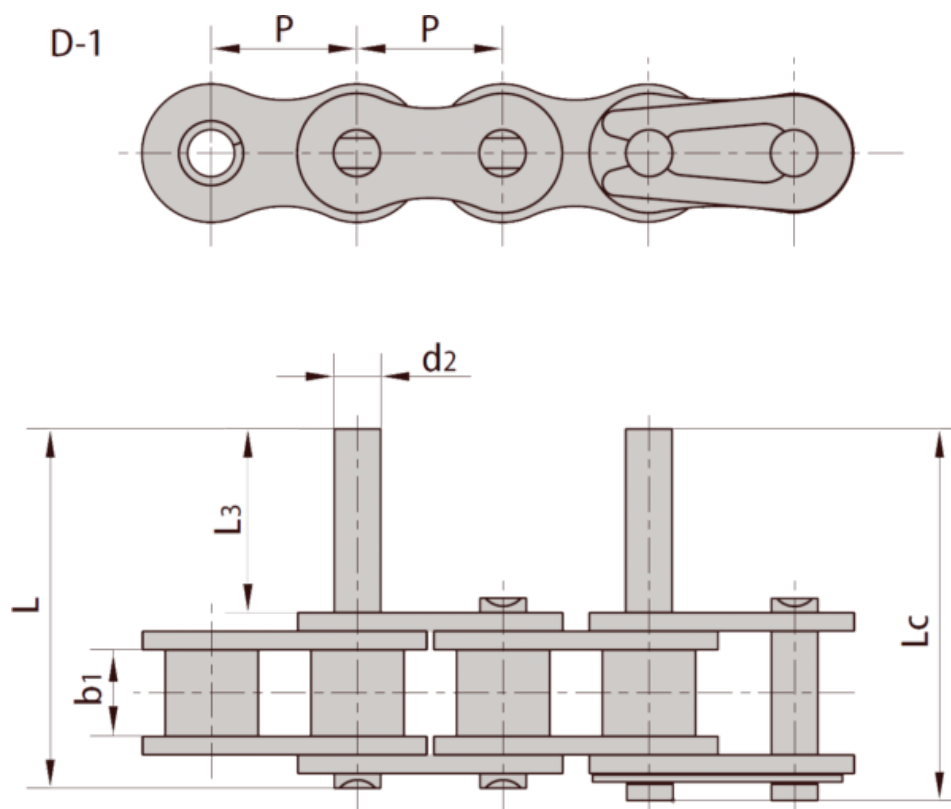

$b1 = 11.68$

$d2 = 5.72$

$L = 35.4$

$L3 = 14.3$

$Lc = 37.1$

$P = 19050$